

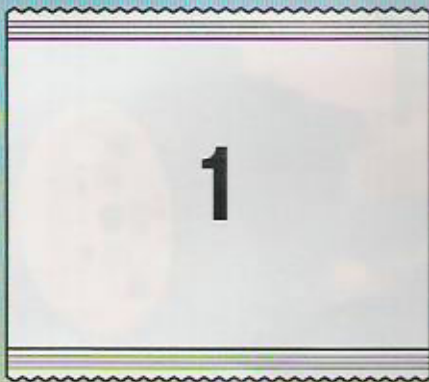

CITY

7344

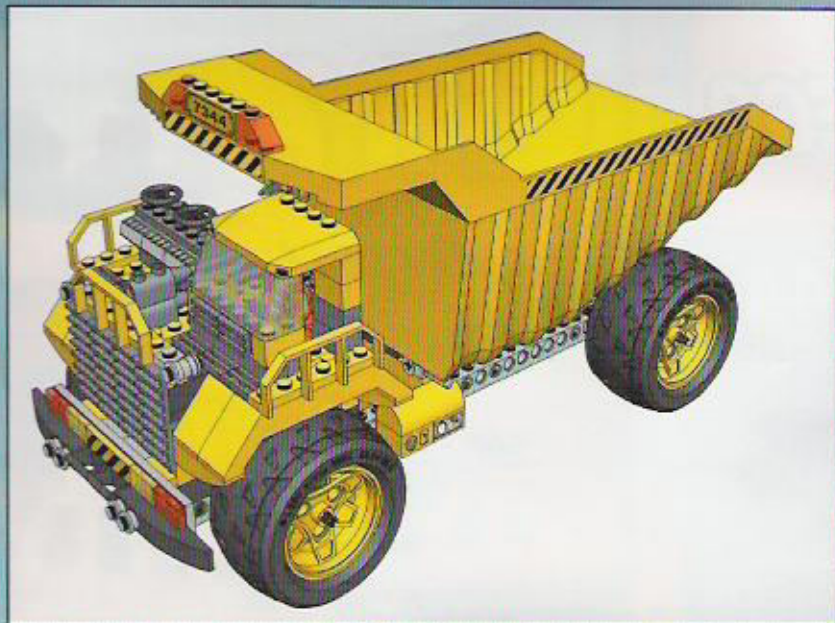



1

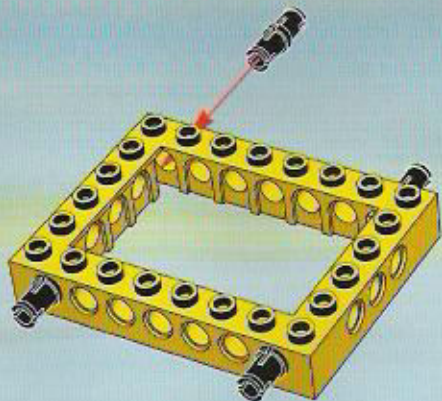

2

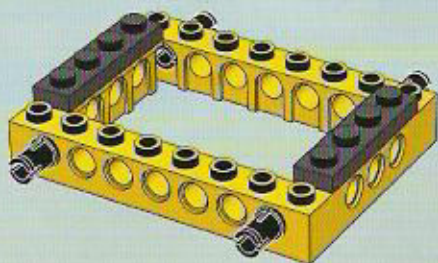

3

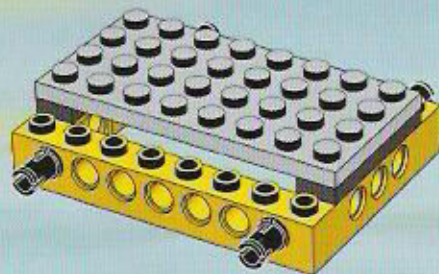

4

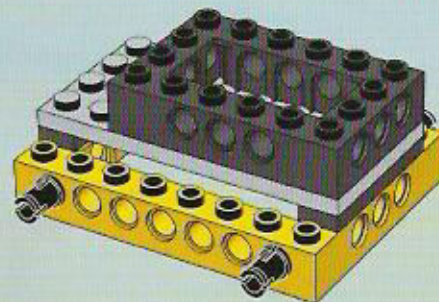

5

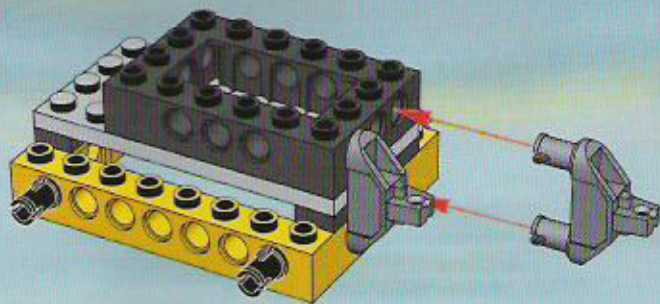

6

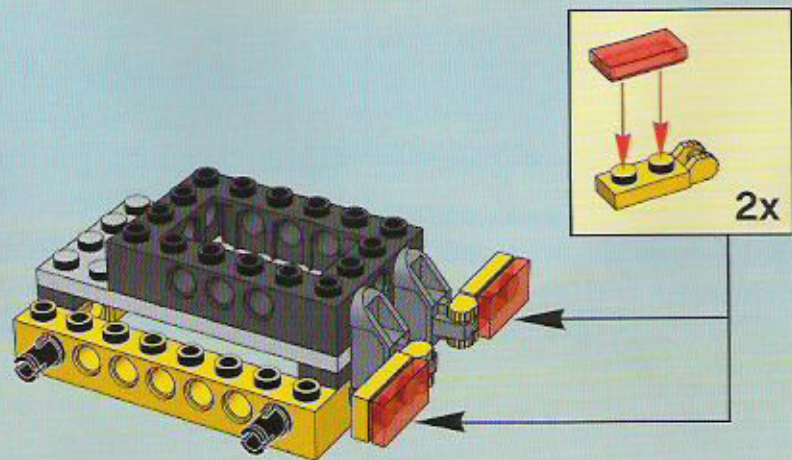

7

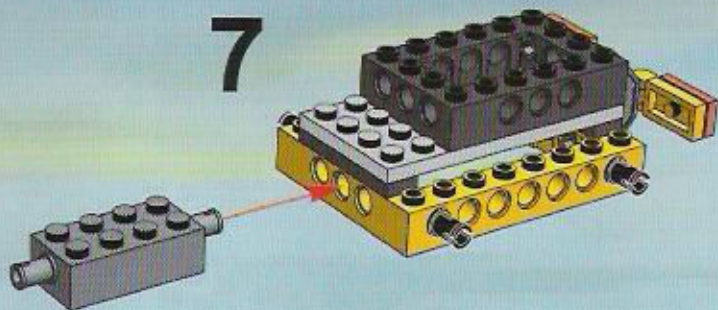

8

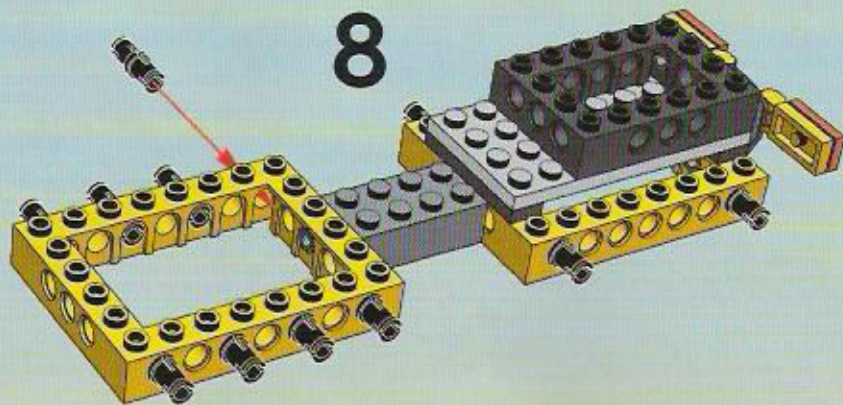

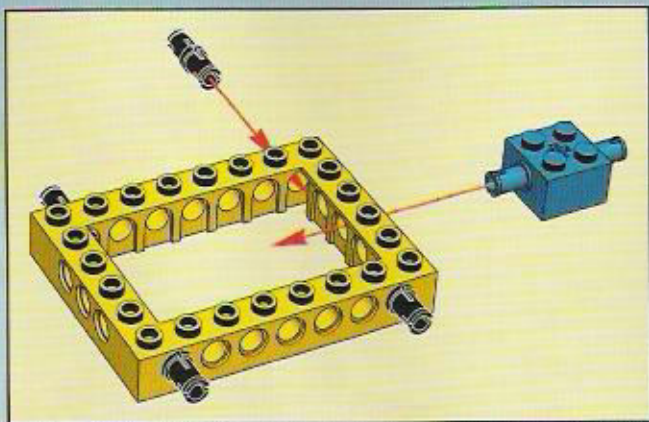

11

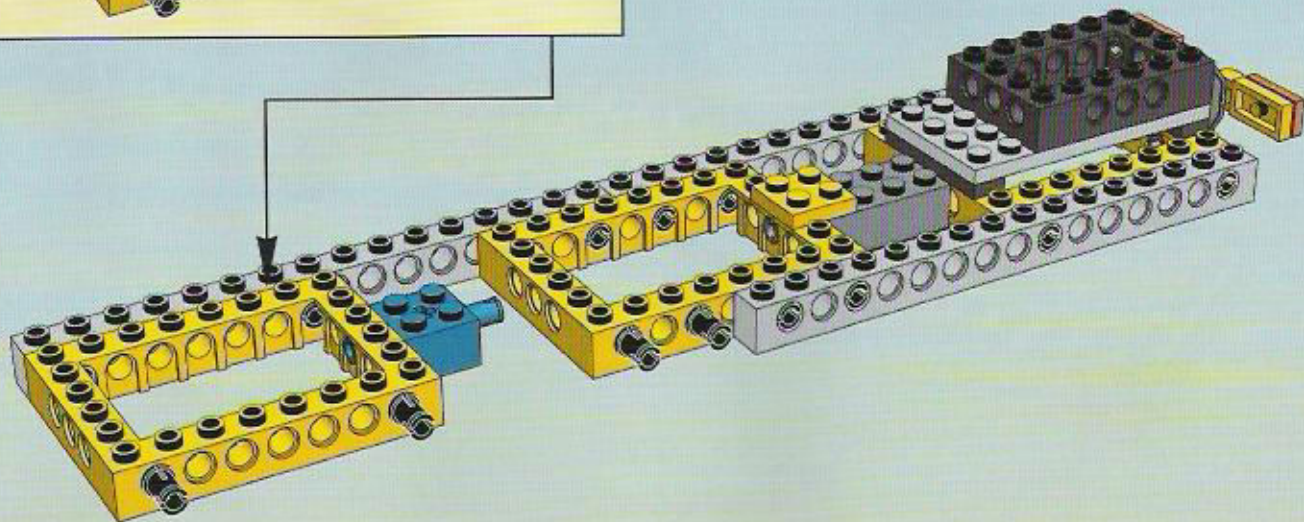

12

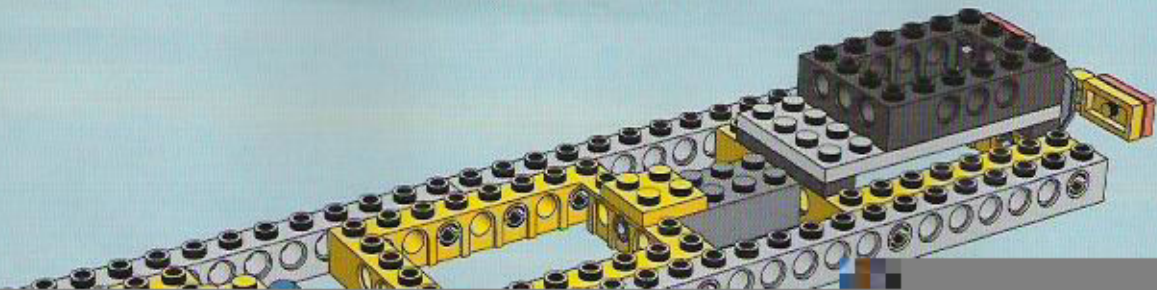

30

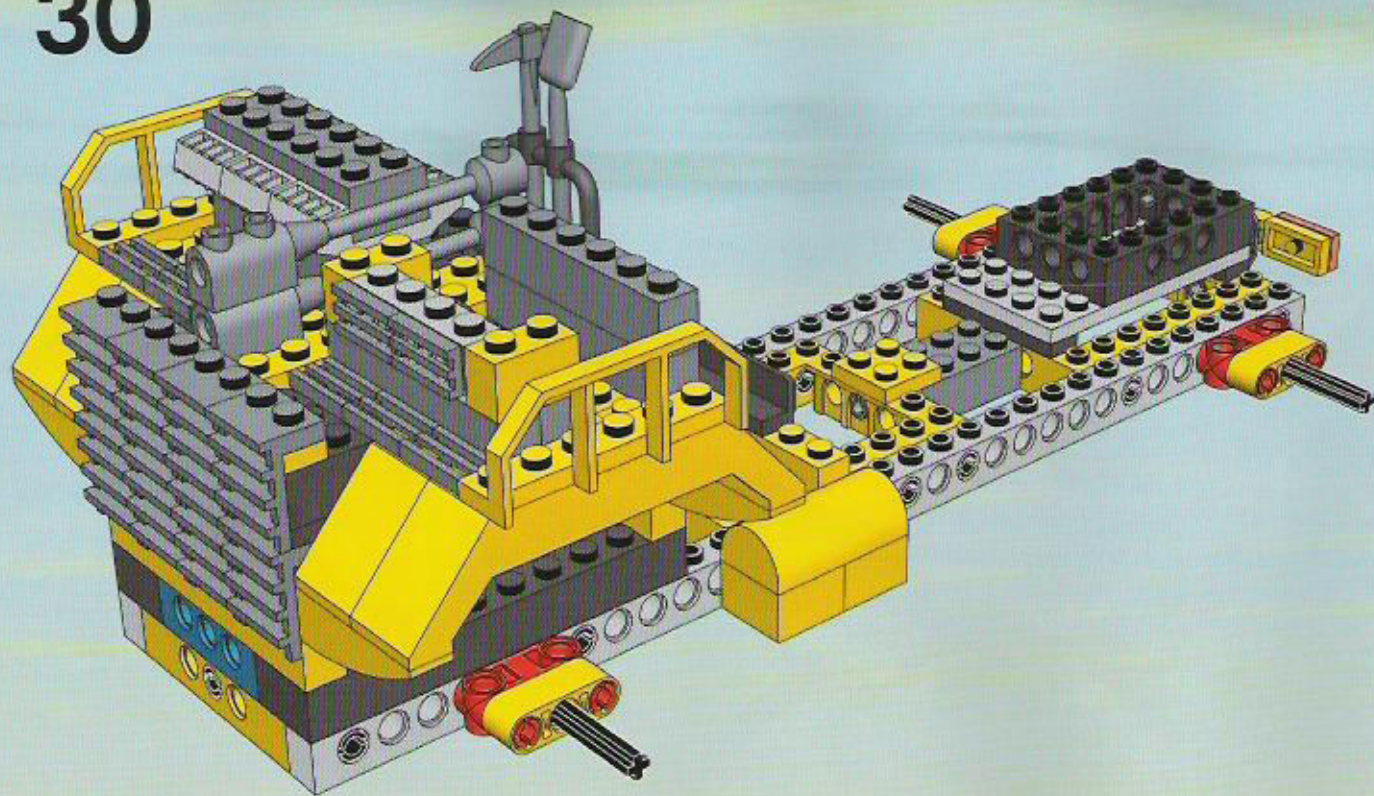

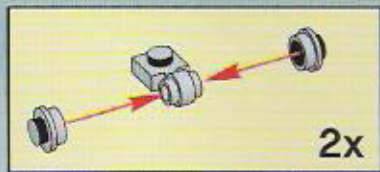

31

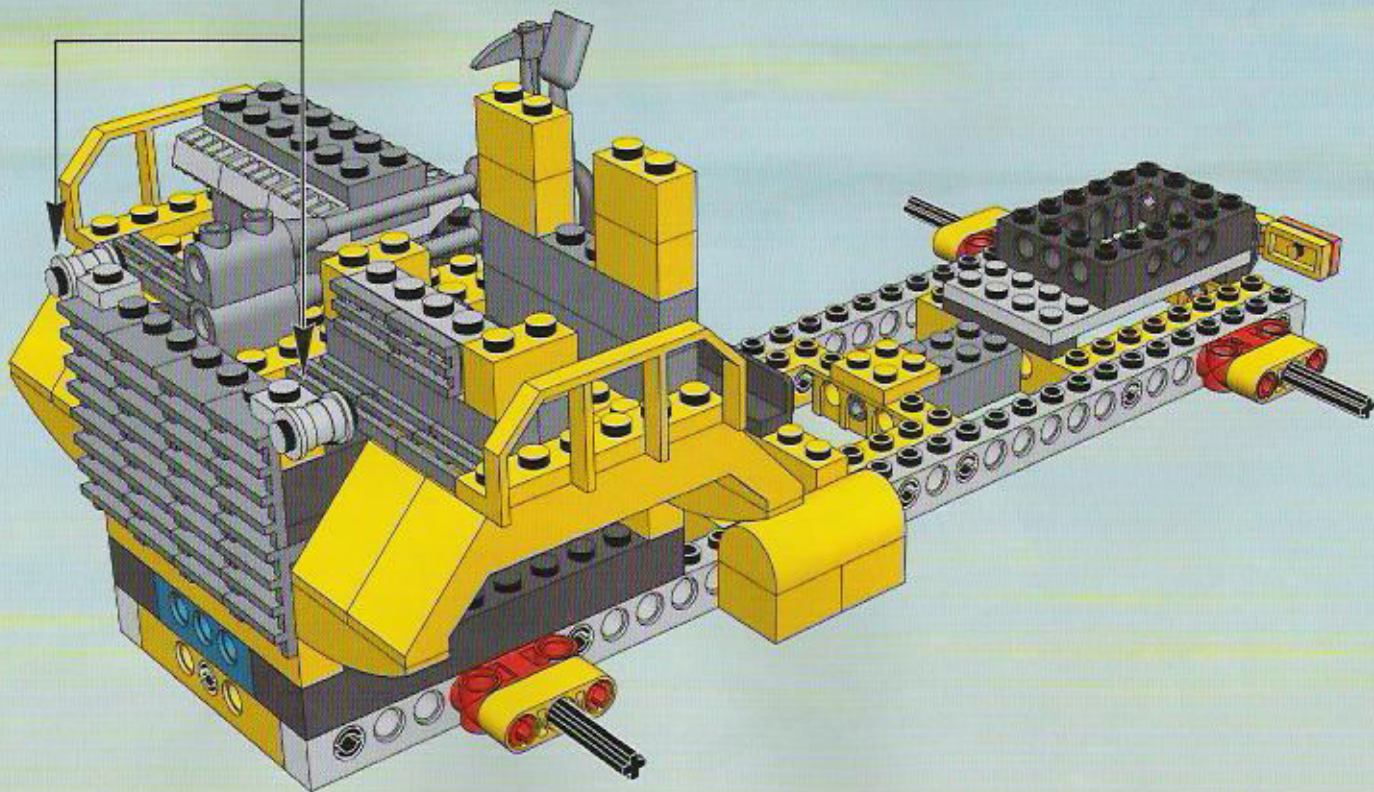

32

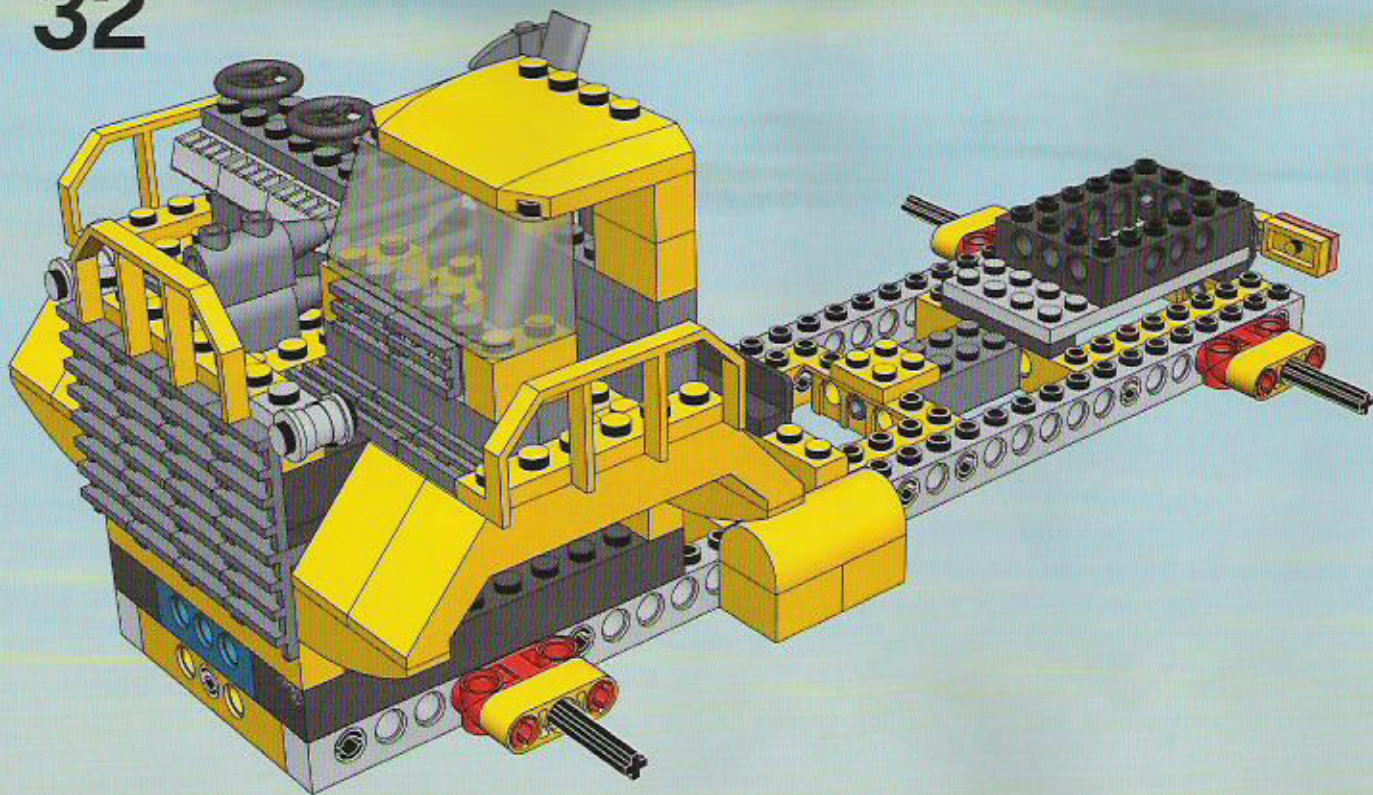

1

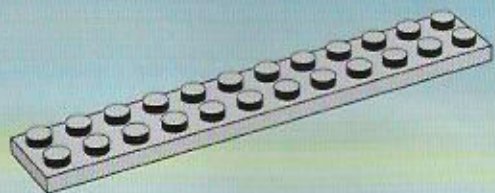

2

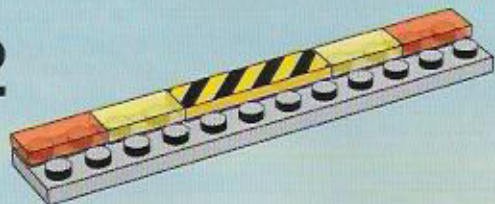

3



4

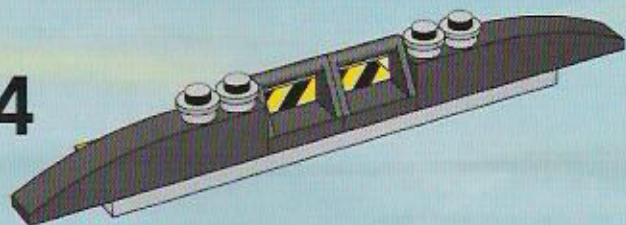

5

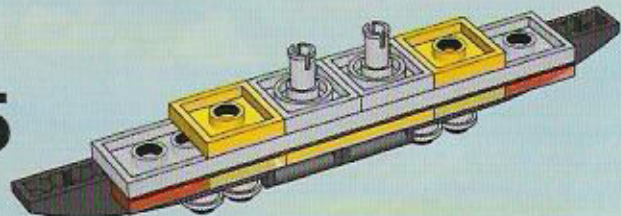

33

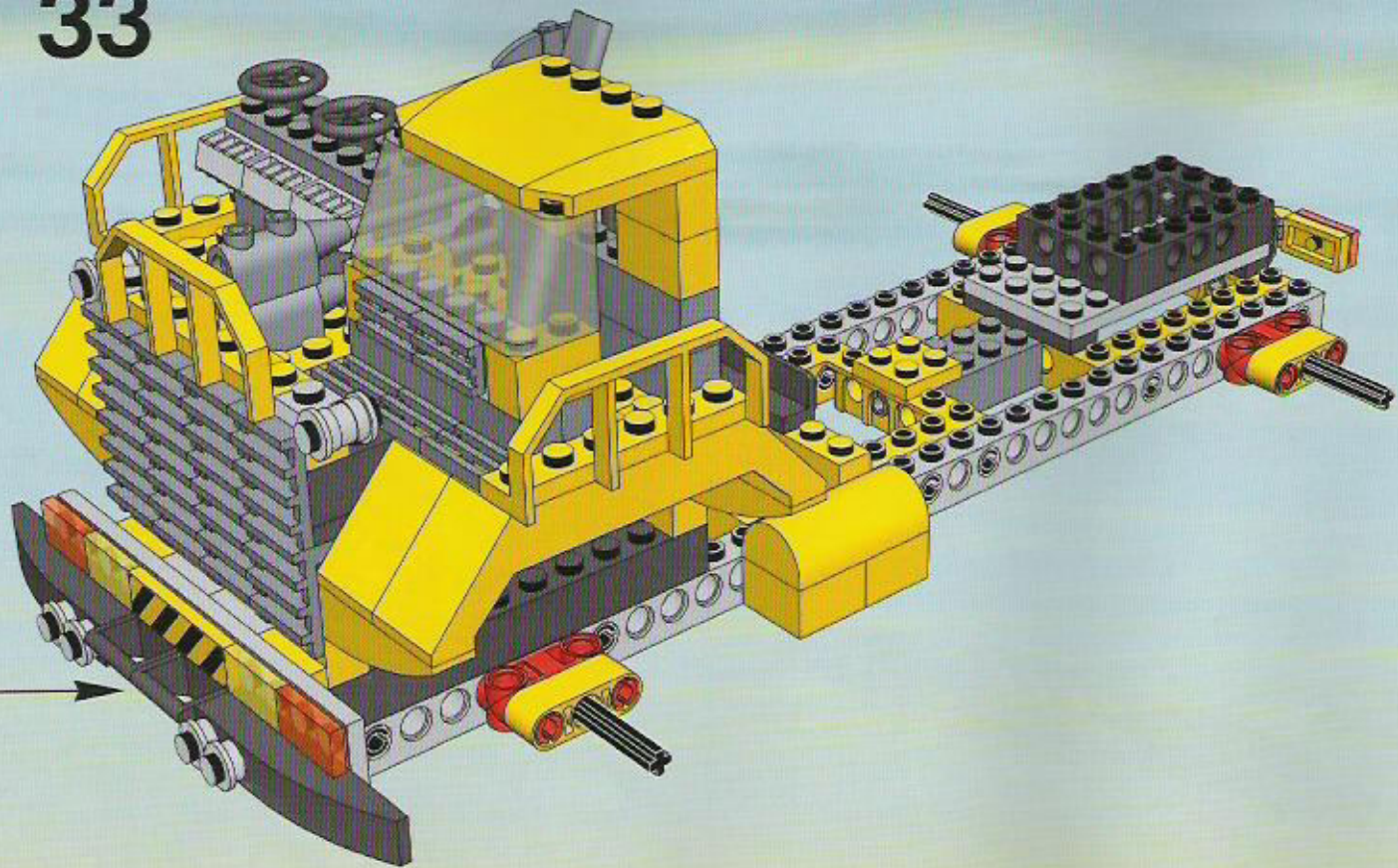

1

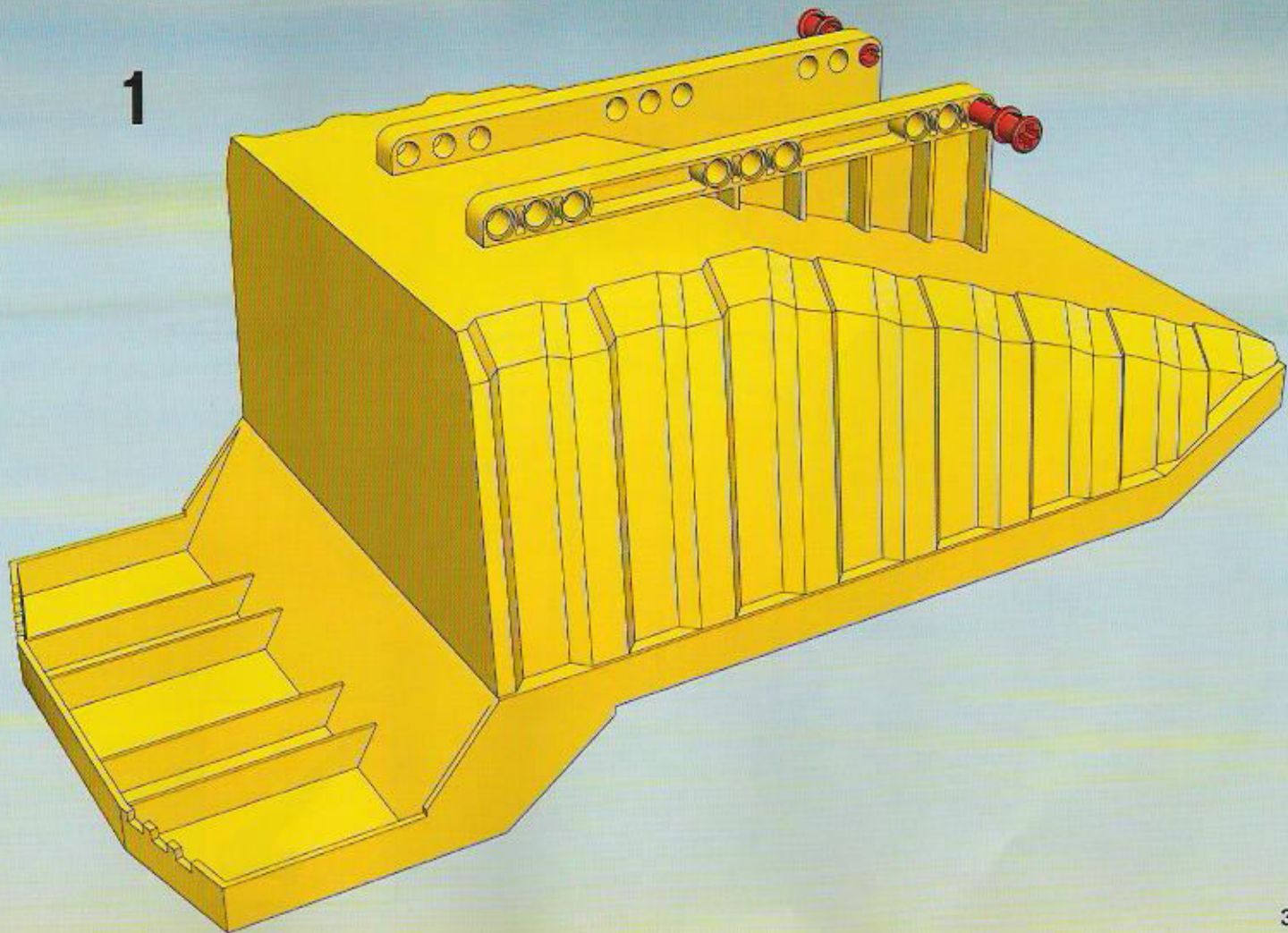

2

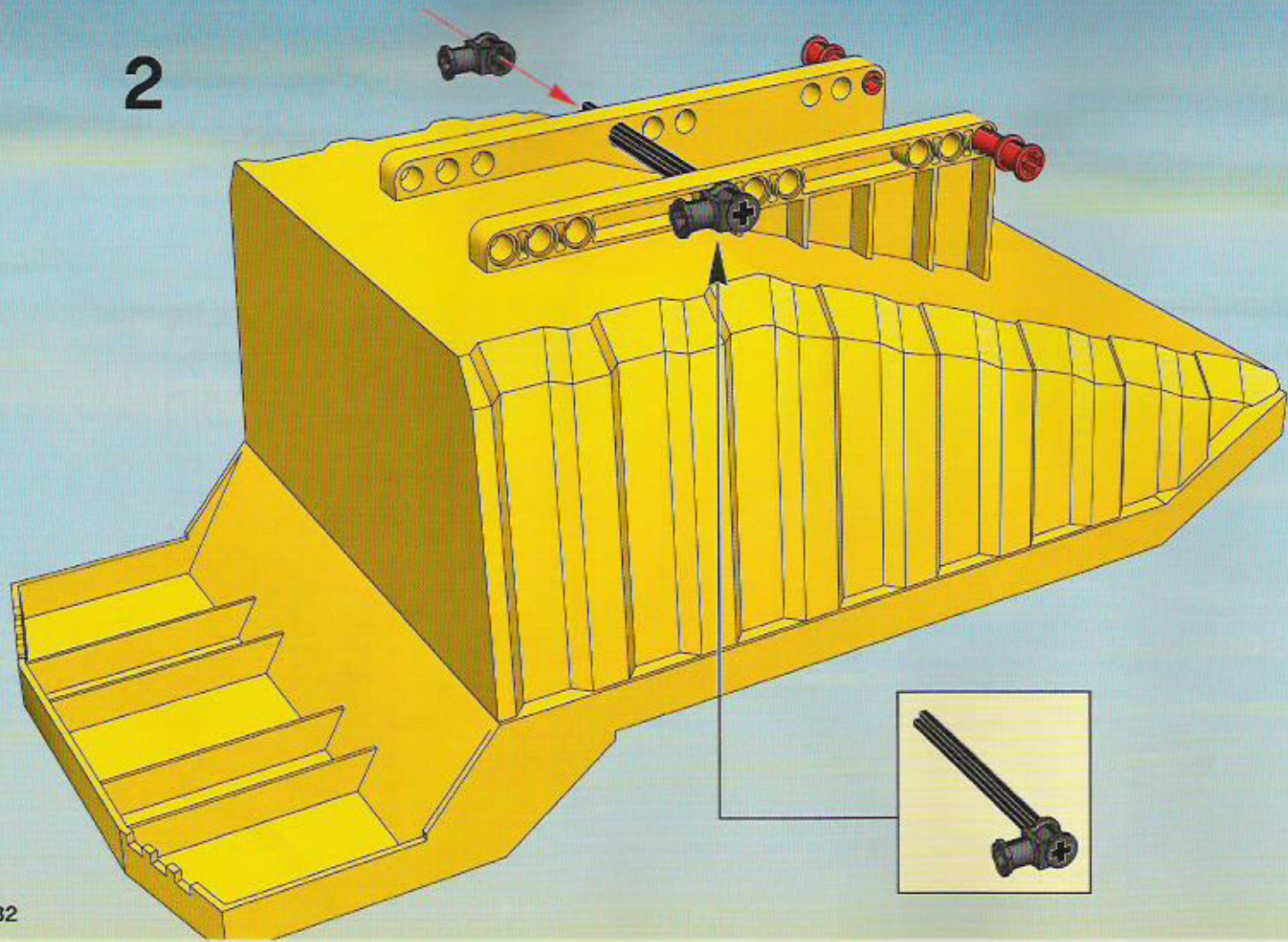

3

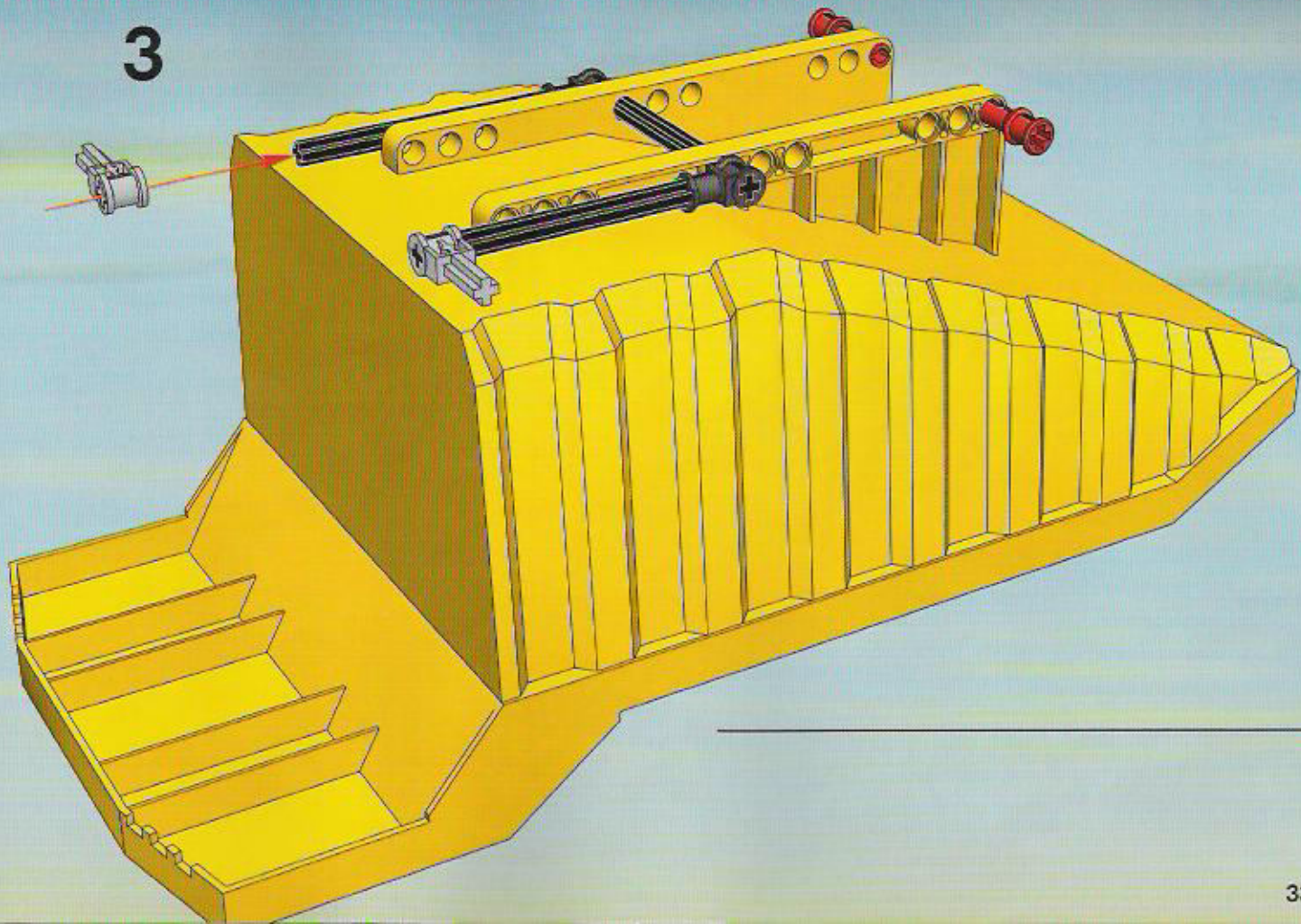

34

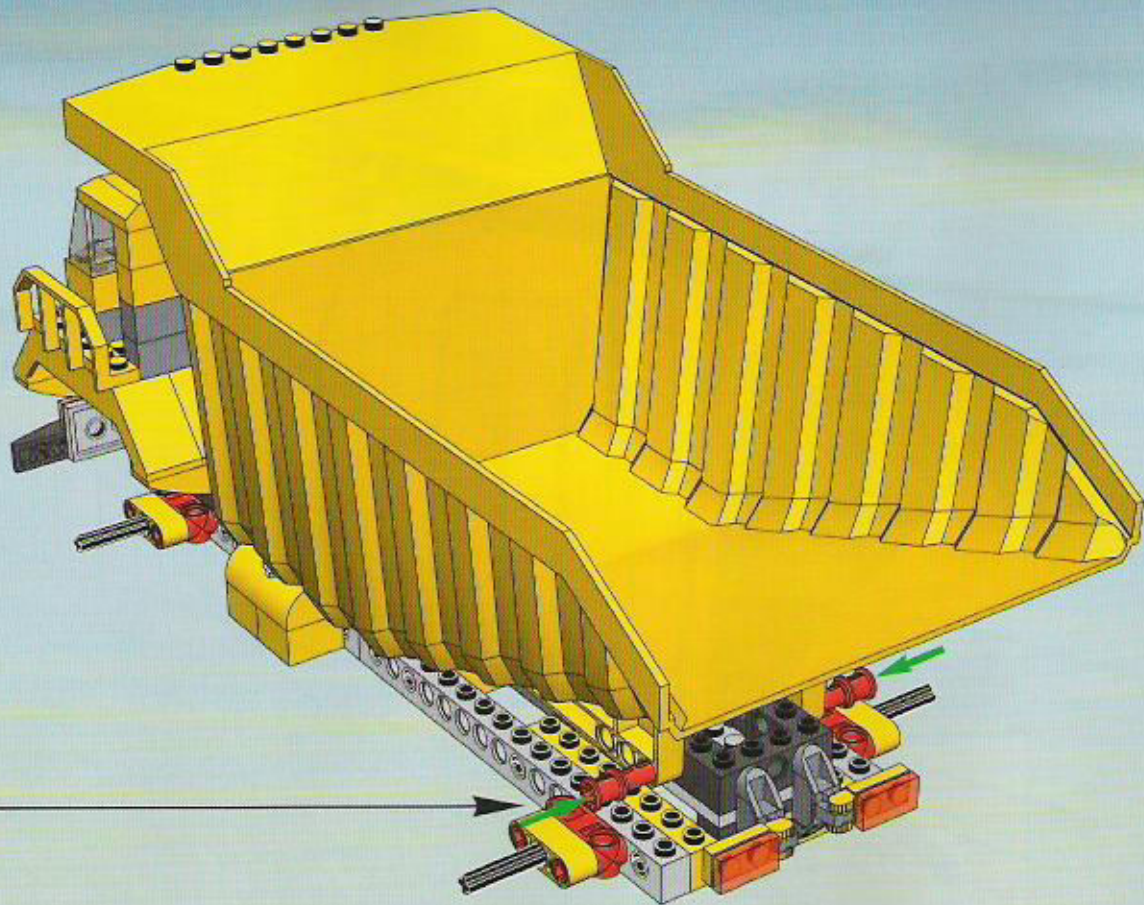

35

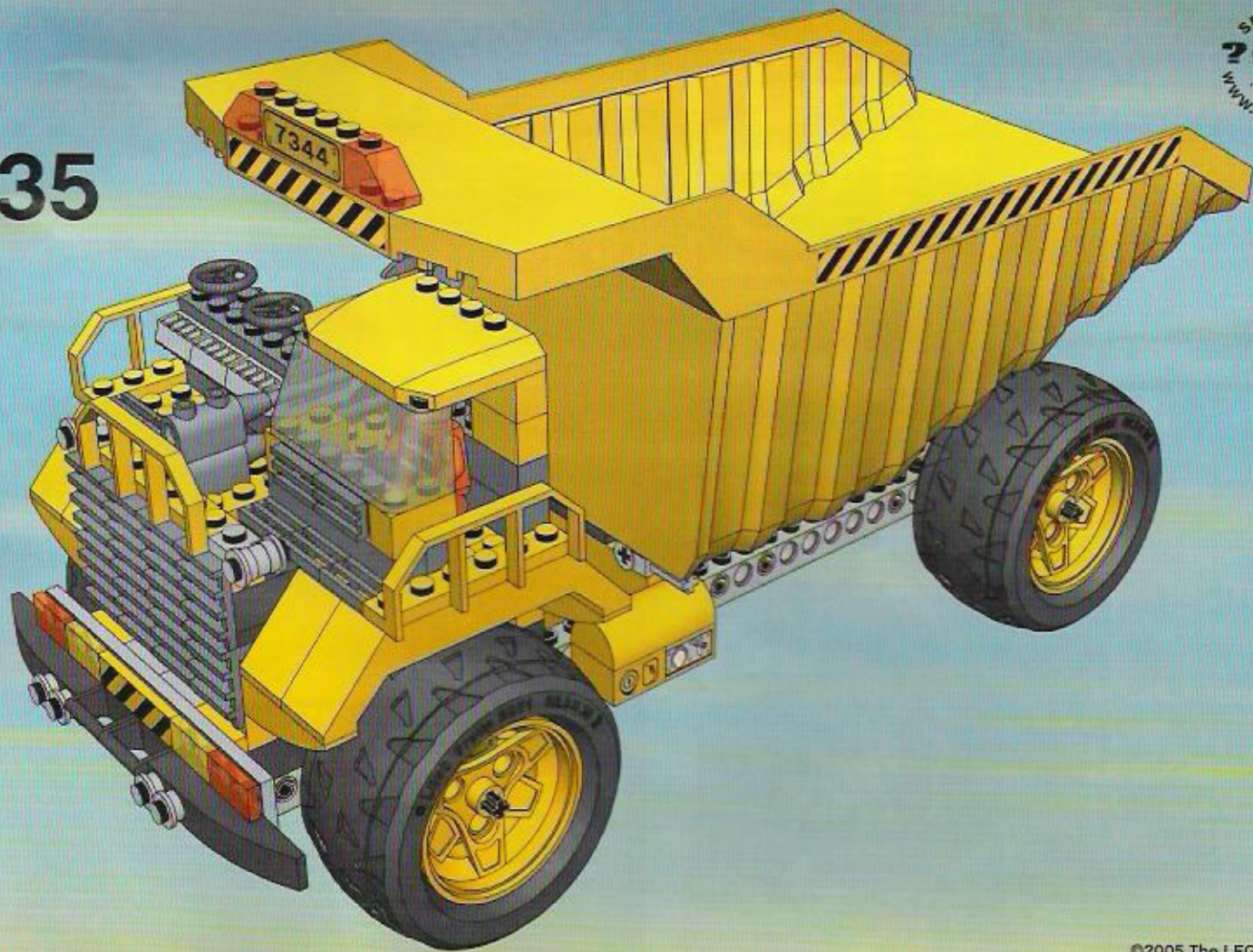

Discover the LEGO® UNIVERSE!



www.LEGOUniverse.com

LEGO SHOP at HOME

The World's
Biggest
LEGO
Shop!



LEGO club



Win!

Gagne!
Gewinne!
当たります!



WIN LEGO® PRODUCTS
We would like to know what you think about our new LEGO® product. Log on to the web address below for further instructions.

GAGNE DES PRODUITS LEGO®
Nous aimerions savoir ce que tu penses de ton nouveau produit LEGO®. Tu obtiendras davantage d'informations en visitant le site Internet indiqué ci-dessous.

GEWINNE LEGO® PRODUKTE
Wir möchten wissen, was du über den neuen LEGO® Produkt denkst. Log dich einfach zu der unten angegebenen Webadresse - dort findest du weitere Informationen.

ESTIMADO USUARIO LEGO®

Al recibirte algunas preguntas en inglés, francés, alemán o japonés en el sitio www.acnielsen.aim.dk/lego, podrás participar en el sorteo de algunas valiosas premios LEGO®.

CAIRO CONSUMIDOR DA LEGO®

As respostas a algumas perguntas em inglês, francês, alemão ou japonês no endereço www.acnielsen.aim.dk/lego irá participar num concurso para ganhar valiosos prémios da LEGO®.

KEMES FANU LEGO® VÁSÁRLÓ

Ha válaszol az néhány kérdésre angol, francia, német vagy japán nyelven megvalósíthatod részvételkedést. A közlés részeként részesülhetsz egy értékes nyeremény, amelyben értékes LEGO® játékok is szerepelnek.

www.acnielsen.aim.dk/LEGO

LEGO, the LEGO logo, the LEGO logo and MINIFIG are trademarks of LEGO Systems A/S, Denmark. LEGO, the LEGO logo and MINIFIG are trademarks of LEGO Systems A/S, Denmark. © 2005 LEGO Systems A/S. All rights reserved. LEGO, the LEGO logo and MINIFIG are trademarks of LEGO Systems A/S, Denmark. © 2005 LEGO Systems A/S. All rights reserved. LEGO, the LEGO logo and MINIFIG are trademarks of LEGO Systems A/S, Denmark. © 2005 LEGO Systems A/S. All rights reserved.

7344



53135/4264780 © 2005 LEGO GROUP